



LD1117/A

LINEAR INTEGRATED CIRCUIT

LOW DROP FIXED AND ADJUSTABLE POSITIVE VOLTAGE REGULATORS

■ DESCRIPTION

The UTC LD1117/A is a low dropout, 3-terminal positive voltage regulator designed to provide output current up to 800mA/1A, There are adjustable version ($V_{REF}=1.25V$) and various fixed versions.

■ FEATURES

- * Low dropout voltage
- * Suitable for SCSI-2 active termination if V_{OUT} set to 2.85V
- * Output current up to 0.8A for 1117 and 1.0A for 1117A
- * Built-in current limit and over temperature protection
- * Available in $\pm 1\%$ (at 25°C) and 2% in all temperature range
- * Low current consumption

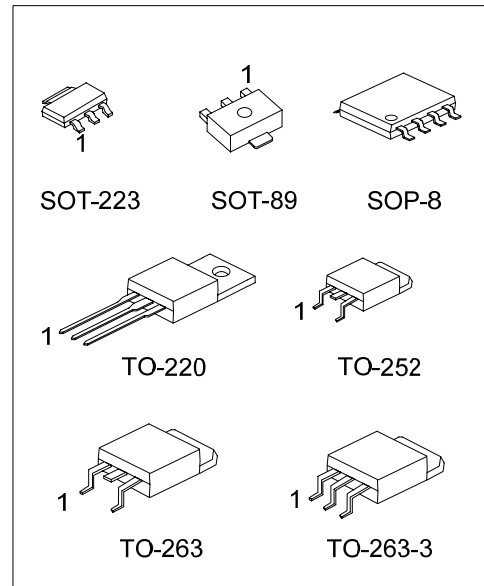

*Pb-free plating product number:
LD1117L-xx / LD1117AL-xx

■ ORDERING INFORMATION

Order Number		Package	② Pin Assignment	③ Packing
Normal	Lead Free Plating			
LD1117①-xx-AA3-②-③	LD1117①L-xx-AA3-②-③	SOT-223	A: GOI B: OGI C: GIO D: IGO	R: Tape Reel T: Tube
LD1117①-xx-AB3-②-③	LD1117①L-xx-AB3-②-③	SOT-89		
LD1117①-xx-TA3-②-③	LD1117①L-xx-TA3-②-③	TO-220		
LD1117①-xx-TN3-②-③	LD1117①L-xx-TN3-②-③	TO-252		
LD1117①-xx-TQ2-②-③	LD1117①L-xx-TQ2-②-③	TO-263		
LD1117①-xx-TQ3-②-③	LD1117①L-xx-TQ3-②-③	TO-263-3		
LD1117①-xx-S08-②-③	LD1117①L-xx-S08-②-③	SOP-8	GOOIxOOx	

Note: Pin Assignment: I: V_{IN} O: V_{OUT} G: GND

	<p>(1)Packing Type (2)Pin Assignment (3)Package Type (4)Output Voltage Code (5)Lead Plating (6)Current Code</p>	<p>(1) R: Tape Reel, T: Tube (2) refer to Pin Assignment (3) AA3: SOT-223, AB3: SOT-89, TA3: TO-220, TN3: TO-252, TQ2: TO-263, TQ3: TO-263-3, S08: SOT-8 (4) xx: refer to Marking Information (5) L: Lead Free Plating, Blank: Pb/Sn (6) Blank: 800mA, A: 1A</p>
--	---	--

MARKING INFORMATION

PACKAGE	VOLTAGE CODE	MARKING
SOT-89		
SOT-223	12 : 1.2V 15 : 1.5V 18 : 1.8V 25 : 2.5V 2J : 2.85V 30 : 3.0V 33 : 3.3V 36 : 3.6V 50 : 5.0V AD : ADJ	
TO-220 TO-252 TO-263 TO-263-3		

Note: Current code: Blank: 0.8A A: 1A

PIN CONFIGURATION

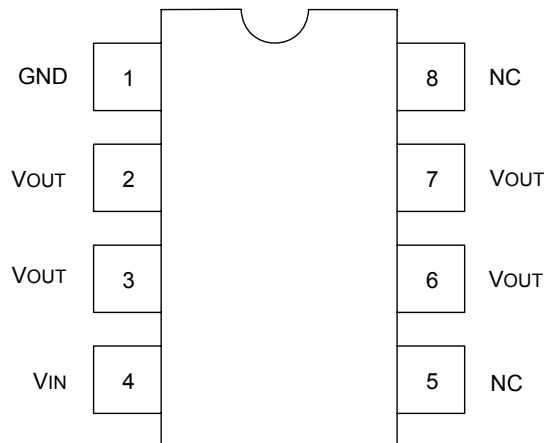

■ BLOCK DIAGRAM

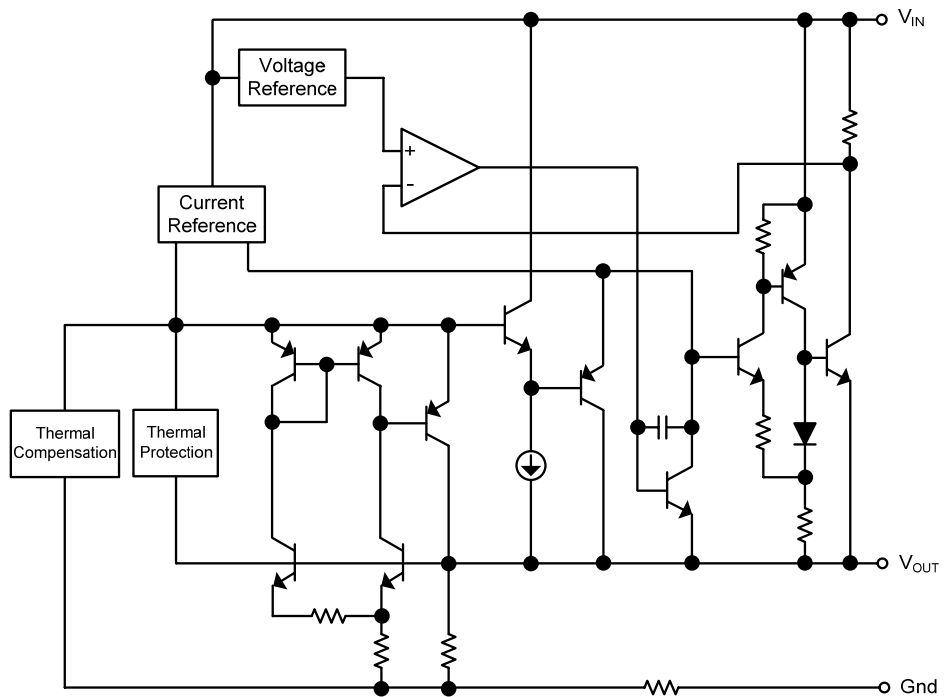

■ ABSOLUTE MAXIMUM RATINGS (Ta=25°C)

PARAMETER	SYMBOL	RATINGS	UNIT
DC Input Voltage	V _{IN}	18	V
Power Dissipation	P _D	Internally limited	
Junction Temperature	T _J	+150	°C
Storage temperature	T _{STG}	-65 ~ +150	°C

Note Absolute maximum ratings are those values beyond which the device could be permanently damaged.

Absolute maximum ratings are stress ratings only and functional device operation is not implied.

■ RECOMMENDED OPERATING RATINGS

PARAMETER	SYMBOL	RATINGS	UNIT
Input Voltage	V _{IN}	15	V
Operating Junction Temperature Range	T _J	0 ~ +125	°C

■ ELECTRICAL CHARACTERISTICS

(Ta=25°C, refer to the test circuits, T_J=0 to 125°C, Co=10μF unless otherwise specified)

For LD1117/A-1.2

PARAMETER	SYMBOL	TEST CONDITIONS	MIN.	TYP.	MAX.	UNIT
Output Voltage	V _{OUT}	V _{IN} =3.2V, I _{OUT} =10mA, T _J =25°C	1.188	1.200	1.212	V
Output Voltage	V _{OUT}	V _{IN} =2.7 to 8V LD1117 : I _{OUT} =0 ~ 800mA LD1117A : I _{OUT} =0 ~ 1.0A	1.176	1.200	1.224	V
Line Regulation	ΔV _{OUT}	V _{IN} =2.7 to 8V, I _{OUT} =0mA		1	6	mV
Load Regulation	ΔV _{OUT}	V _{IN} =2.7V LD1117 : I _{OUT} =0 ~ 800mA LD1117A : I _{OUT} =0 ~ 1000mA		1	10	mV
Temperature stability	ΔV _{OUT}			0.5		%
Long Term Stability	ΔV _{OUT}	1000 hrs, T _J =125°C		0.3		%
Operating Input Voltage	V _{IN}	I _{OUT} =100mA			15	V
Quiescent Current	I _Q	V _{IN} ≤10V		5	10	mA
Current Limit	I _{LIMIT}	V _{IN} =6.2V, T _J =25°C	LD1117	800		mA
			LD1117A	1000		
Minimum Load Current	I _{O(MIN)}	V _{IN} =15V		2	5	mA
Output Noise Voltage	eN	B=10Hz to 10KHz, T _J =25°C		100		μV
Supply Voltage Rejection	SVR	I _{OUT} =40mA, f=120Hz, T _J =25°C, V _{IN} =4.2V, V _{RIPPLE} =1Vpp	60	75		dB
Dropout Voltage	V _D	I _{OUT} =100mA I _{OUT} =500mA I _{OUT} =800mA I _{OUT} =1000 mA		1.00	1.10	V
				1.15	1.25	V
				1.20	1.30	V
				1.20	1.30	V
Thermal Regulation		Ta=25°C, 30ms Pulse		0.01	0.10	%/W

■ ELECTRICAL CHARACTERISTICS(Cont.)

For LD1117/A-1.5

PARAMETER	SYMBOL	TEST CONDITIONS	MIN.	TYP.	MAX.	UNIT
Output Voltage	V_{OUT}	$V_{IN}=3.5V, I_{OUT}=10mA, T_J=25^{\circ}C$	1.485	1.500	1.515	V
Output Voltage	V_{OUT}	$V_{IN}=3$ to 8V LD1117 : $I_{OUT}=0 \sim 800mA$ LD1117A : $I_{OUT}=0 \sim 1.0A$	1.470	1.500	1.530	V
Line Regulation	ΔV_{OUT}	$V_{IN}=3$ to 8V, $I_{OUT}=0mA$		1	6	mV
Load Regulation	ΔV_{OUT}	$V_{IN}=3V$ LD1117 : $I_{OUT}=0 \sim 800mA$ LD1117A : $I_{OUT}=0 \sim 1000mA$		1	10	mV
Temperature stability	ΔV_{OUT}			0.5		%
Long Term Stability	ΔV_{OUT}	1000 hrs, $T_J=125^{\circ}C$		0.3		%
Operating Input Voltage	V_{IN}	$I_{OUT}=100mA$			15	V
Quiescent Current	I_Q	$V_{IN} \leq 10V$		5	10	mA
Current Limit	I_{LIMIT}	$V_{IN}=6.5V, T_J=25^{\circ}C$	LD1117	800		mA
			LD1117A	1000		
Output Noise Voltage	eN	B=10Hz to 10KHz, $T_J=25^{\circ}C$		100		μV
Supply Voltage Rejection	SVR	$I_{OUT}=40mA, f=120Hz, T_J=25^{\circ}C,$ $V_{IN}=4.5V, V_{RIPPLE}=1V_{pp}$	60	75		dB
Dropout Voltage	V_D		$I_{OUT}=100mA$	1.00	1.10	V
			$I_{OUT}=500mA$	1.15	1.25	V
			$I_{OUT}=800mA$	1.20	1.30	V
			$I_{OUT}=1000 mA$	1.20	1.30	V
Thermal Regulation		$T_a=25^{\circ}C, 30ms$ Pulse		0.01	0.10	%/W

For LD1117/A-1.8

PARAMETER	SYMBOL	TEST CONDITIONS	MIN.	TYP.	MAX.	UNIT
Output Voltage	V_{OUT}	$V_{IN}=3.8V, I_{OUT}=10mA, T_J=25^{\circ}C$	1.780	1.800	1.820	V
Output Voltage	V_{OUT}	$V_{IN}=3.3$ to 8V LD1117 : $I_{OUT}=0 \sim 800mA$ LD1117A : $I_{OUT}=0 \sim 1000mA$	1.760	1.800	1.840	V
Line Regulation	ΔV_{OUT}	$V_{IN}=3.3$ to 8V, $I_{OUT}=0mA$		1	6	mV
Load Regulation	ΔV_{OUT}	$V_{IN}=3.3V$ LD1117 : $I_{OUT}=0 \sim 800mA$ LD1117A : $I_{OUT}=0 \sim 1000mA$		1	10	mV
Temperature stability	ΔV_{OUT}			0.5		%
Long Term Stability	ΔV_{OUT}	1000 hrs, $T_J=125^{\circ}C$		0.3		%
Operating Input Voltage	V_{IN}	$I_{OUT}=100mA$			10	V
Quiescent Current	I_Q	$V_{IN} \leq 8V$		5	10	mA
Current Limit	I_{LIMIT}	$V_{IN}=6.8V, T_J=25^{\circ}C$	LD1117	800		mA
			LD1117A	1000		
Output Noise Voltage	eN	B=10Hz to 10KHz, $T_J=25^{\circ}C$		100		μV
Supply Voltage Rejection	SVR	$I_{OUT}=40mA, f=120Hz, T_J=25^{\circ}C,$ $V_{IN}=5.5V, V_{RIPPLE}=1V_{pp}$	60	75		dB
Dropout Voltage	V_D		$I_{OUT}=100mA$	1.00	1.10	V
			$I_{OUT}=500mA$	1.15	1.25	V
			$I_{OUT}=800mA$	1.20	1.30	V
			$I_{OUT}=1000 mA$	1.20	1.30	V
Thermal Regulation		$T_a=25^{\circ}C, 30ms$ Pulse		0.01	0.10	%/W

■ ELECTRICAL CHARACTERISTICS(Cont.)

For LD1117/A-2.5

PARAMETER	SYMBOL	TEST CONDITIONS	MIN.	TYP.	MAX.	UNIT	
Output Voltage	V_{OUT}	$V_{IN}=4.5V, I_{OUT}=10mA, T_J=25^{\circ}C$	1%	2.475	2.500	2.525	V
			2%	2.450	2.500	2.550	
Output Voltage	V_{OUT}	$V_{IN}=3.9$ to 10V LD1117 : $I_{OUT}=0 \sim 800mA$ LD1117A : $I_{OUT}=0 \sim 1.0A$	2%	2.450	2.500	2.550	V
			4%	2.400	2.500	2.600	
Line Regulation	ΔV_{OUT}	$V_{IN}=3.9$ to 10V, $I_{OUT}=0mA$		1	6	mV	
Load Regulation	ΔV_{OUT}	$V_{IN}=3.9V$ LD1117 : $I_{OUT}=0 \sim 800mA$ LD1117A : $I_{OUT}=0 \sim 1000mA$		1	10	mV	
Temperature stability	ΔV_{OUT}			0.5		%	
Long Term Stability	ΔV_{OUT}	1000 hrs, $T_J = 125^{\circ}C$		0.3		%	
Operating Input Voltage	V_{IN}	$I_{OUT}=100mA$			15	V	
Quiescent Current	I_Q	$V_{IN} \leq 10V$		5	10	mA	
Current Limit	I_{LIMIT}	$V_{IN}=7.5V, T_J = 25^{\circ}C$	LD1117	800			mA
			LD1117A	1000			
Output Noise Voltage	eN	B=10Hz to 10KHz, $T_J = 25^{\circ}C$		100		μV	
Supply Voltage Rejection	SVR	$I_{OUT}=40mA, f=120Hz, T_J = 25^{\circ}C, V_{IN}=5.5V, V_{ripple}=1V_{pp}$	60	75		dB	
Dropout Voltage	V_D	$I_{OUT}=100mA$ $I_{OUT}=500mA$ $I_{OUT}=800mA$ $I_{OUT}=1000mA$		1.00	1.10	V	
				1.15	1.25	V	
				1.20	1.30	V	
				1.20	1.30	V	
Thermal Regulation		$T_a=25^{\circ}C, 30ms$ Pulse		0.01	0.10	%/W	

For LD1117/A-2.85

PARAMETER	SYMBOL	TEST CONDITIONS	MIN.	TYP.	MAX.	UNIT
Output Voltage	V_{OUT}	$V_{IN}=4.85V, I_{OUT}=10mA, T_J = 25^{\circ}C$	2.828	2.850	2.880	V
Output Voltage	V_{OUT}	$V_{IN}=4.25$ to 10V LD1117 : $I_{OUT}=0 \sim 800mA$ LD1117A : $I_{OUT}=0 \sim 1.0A$	2.790	2.850	2.910	V
Line Regulation	ΔV_{OUT}	$V_{IN}=4.25$ to 10V, $I_{OUT}=0mA$		1	6	mV
Load Regulation	ΔV_{OUT}	$V_{IN}=4.25V$ LD1117 : $I_{OUT}=0 \sim 800mA$ LD1117A : $I_{OUT}=0 \sim 1000mA$		1	10	mV
Temperature stability	ΔV_{OUT}			0.5		%
Long Term Stability	ΔV_{OUT}	1000 hrs, $T_J = 125^{\circ}C$		0.3		%
Operating Input Voltage	V_{IN}	$I_{OUT}=100mA$			15	V
Quiescent Current	I_Q	$V_{IN} \leq 10V$		5	10	mA
Current Limit	I_{LIMIT}	$V_{IN}=7.85V, T_J = 25^{\circ}C$	LD1117	800		mA
			LD1117A	1000		
Output Noise Voltage	eN	B=10Hz to 10KHz, $T_J = 25^{\circ}C$		100		μV
Supply Voltage Rejection	SVR	$I_{OUT}=40mA, f=120Hz, T_J = 25^{\circ}C, V_{IN}=5.85V, V_{ripple}=1V_{pp}$	60	75		dB
Dropout Voltage	V_D	$I_{OUT}=100mA$ $I_{OUT}=500mA$ $I_{OUT}=800mA$ $I_{OUT}=1000mA$		1.00	1.10	V
				1.15	1.25	V
				1.20	1.30	V
				1.20	1.30	V
Thermal Regulation		$T_a=25^{\circ}C, 30ms$ Pulse		0.01	0.10	%/W

■ ELECTRICAL CHARACTERISTICS(Cont.)

For LD1117/A-3.0

PARAMETER	SYMBOL	TEST CONDITIONS	MIN.	TYP.	MAX.	UNIT	
Output Voltage	V_{OUT}	$V_{IN}=5V, I_{OUT}=10mA, T_J=25^{\circ}C$	1%	2.970	3.000	3.030	V
			2%	2.940	3.000	3.060	
Output Voltage	V_{OUT}	$V_{IN}=4.5$ to 10V LD1117 : $I_{OUT}=0 \sim 800mA$ LD1117A : $I_{OUT}=0 \sim 1.0A$	2%	2.940	3.000	3.060	V
			4%	2.880	3.000	3.120	
Line Regulation	ΔV_{OUT}	$V_{IN}=4.5$ to 12V, $I_{OUT}=0mA$		1	6	mV	
Load Regulation	ΔV_{OUT}	$V_{IN}=4.5V$ LD1117 : $I_{OUT}=0 \sim 800mA$ LD1117A : $I_{OUT}=0 \sim 1000mA$		1	10	mV	
Temperature stability	ΔV_{OUT}			0.5		%	
Long Term Stability	ΔV_{OUT}	1000 hrs, $T_J=125^{\circ}C$		0.3		%	
Operating Input Voltage	V_{IN}	$I_{OUT}=100mA$			15	V	
Quiescent Current	I_Q	$V_{IN} \leq 10V$		5	10	mA	
Current Limit	I_{LIMIT}	$V_{IN}=8V, T_J=25^{\circ}C$	LD1117	800			mA
			LD1117A	1000			
Output Noise Voltage	eN	B=10Hz to 10KHz, $T_J=25^{\circ}C$		100		μV	
Supply Voltage Rejection	SVR	$I_{OUT}=40mA, f=120Hz, T_J=25^{\circ}C,$ $V_{IN}=6V, V_{RIPPLE}=1V_{pp}$	60	75		dB	
Dropout Voltage	V_D	$I_{OUT}=100mA$ $I_{OUT}=500mA$ $I_{OUT}=800mA$ $I_{OUT}=1000mA$		1.00	1.10	V	
				1.15	1.25	V	
				1.20	1.30	V	
				1.20	1.30	V	
Thermal Regulation		$T_a=25^{\circ}C, 30ms$ Pulse		0.01	0.10	%/W	

For LD1117/A-3.3

PARAMETER	SYMBOL	TEST CONDITIONS	MIN.	TYP.	MAX.	UNIT	
Output Voltage	V_{OUT}	$V_{IN}=5.3V, I_{OUT}=10mA,$ $T_J=25^{\circ}C$	1%	3.267	3.300	3.333	V
			2%	3.235	3.300	3.365	
Output Voltage	V_{OUT}	$V_{IN}=4.75$ to 10V LD1117 : $I_{OUT}=0 \sim 800mA$ LD1117A : $I_{OUT}=0 \sim 1.0A$	2%	3.235	3.300	3.365	V
			4%	3.160	3.300	3.440	
Line Regulation	ΔV_{OUT}	$V_{IN}=4.75$ to 15V, $I_{OUT}=0mA$		1	6	mV	
Load Regulation	ΔV_{OUT}	$V_{IN}=4.75V$ LD1117 : $I_{OUT}=0 \sim 800mA$ LD1117A : $I_{OUT}=0 \sim 1000mA$		1	10	mV	
Temperature stability	ΔV_{OUT}			0.5		%	
Long Term Stability	ΔV_{OUT}	1000 hrs, $T_J=125^{\circ}C$		0.3		%	
Operating Input Voltage	V_{IN}	$I_{OUT}=100mA$			15	V	
Quiescent Current	I_Q	$V_{IN} \leq 15V$		5	10	mA	
Current Limit	I_{LIMIT}	$V_{IN}=8.3V, T_J=25^{\circ}C$	LD1117	800			mA
			LD1117A	1000			
Output Noise Voltage	eN	B=10Hz to 10KHz, $T_J=25^{\circ}C$		100		μV	
Supply Voltage Rejection	SVR	$I_{OUT}=40mA, f=120Hz, T_J=25^{\circ}C,$ $V_{IN}=6.3V, V_{RIPPLE}=1V_{pp}$	60	75		dB	
Dropout Voltage	V_D	$I_{OUT}=100mA$ $I_{OUT}=500mA$ $I_{OUT}=800mA$ $I_{OUT}=1000mA$		1.00	1.10	V	
				1.15	1.25	V	
				1.20	1.30	V	
				1.20	1.30	V	
Thermal Regulation		$T_a=25^{\circ}C, 30ms$ Pulse		0.01	0.10	%/W	

■ ELECTRICAL CHARACTERISTICS(Cont.)

For LD1117/A-3.6

PARAMETER	SYMBOL	TEST CONDITIONS	MIN.	TYP.	MAX.	UNIT
Output Voltage	V_{OUT}	$V_{IN}=5.6V, I_{OUT}=10mA, T_J=25^{\circ}C$	3.564	3.600	3.636	V
Output Voltage	V_{OUT}	$V_{IN}=5$ to 10V LD1117 : $I_{OUT}=0 \sim 800mA$ LD1117A : $I_{OUT}=0 \sim 1.0A$	3.528	3.600	3.672	V
Line Regulation	ΔV_{OUT}	$V_{IN}=5$ to 15V, $I_{OUT}=0mA$		1	6	mV
Load Regulation	ΔV_{OUT}	$V_{IN}=5V$ LD1117 : $I_{OUT}=0 \sim 800mA$ LD1117A : $I_{OUT}=0 \sim 1000mA$		1	10	mV
Temperature stability	ΔV_{OUT}			0.5		%
Long Term Stability	ΔV_{OUT}	1000 hrs, $T_J=125^{\circ}C$		0.3		%
Operating Input Voltage	V_{IN}	$I_{OUT}=100mA$			15	V
Quiescent Current	I_Q	$V_{IN} \leq 15V$		5	10	mA
Current Limit	I_{LIMIT}	$V_{IN}=8.6V, T_J=25^{\circ}C$	LD1117	800		mA
			LD1117A	1000		
Output Noise Voltage	eN	B=10Hz to 10KHz, $T_J=25^{\circ}C$		100		μV
Supply Voltage Rejection	SVR	$I_{OUT}=40mA, f=120Hz, T_J=25^{\circ}C,$ $V_{IN}=6.6V, V_{RIPPLE}=1V_{pp}$	60	75		dB
Dropout Voltage	V_D	$I_{OUT}=100mA$ $I_{OUT}=500mA$ $I_{OUT}=800mA$ $I_{OUT}=1000mA$		1.00	1.10	V
				1.15	1.25	V
				1.20	1.30	V
				1.20	1.30	V
Thermal Regulation		$T_a=25^{\circ}C, 30ms$ Pulse		0.01	0.10	%/W

For LD1117/A-5.0

PARAMETER	SYMBOL	TEST CONDITIONS	MIN.	TYP.	MAX.	UNIT	
Output Voltage	V_{OUT}	$V_{IN}=7V, I_{OUT}=10mA, T_J=25^{\circ}C$	1%	4.950	5.000	5.050	V
			2%	4.900	5.000	5.100	
Output Voltage	V_{OUT}	$V_{IN}=6.5$ to 15V LD1117 : $I_{OUT}=0 \sim 800mA$ LD1117A : $I_{OUT}=0 \sim 1.0A$	2%	4.900	5.000	5.100	V
			4%	4.800	5.000	5.200	
Line Regulation	ΔV_{OUT}	$V_{IN}=6.5$ to 15V, $I_{OUT}=0mA$		1	6	mV	
Load Regulation	ΔV_{OUT}	$V_{IN}=6.5V$ LD1117 : $I_{OUT}=0 \sim 800mA$ LD1117A : $I_{OUT}=0 \sim 1000mA$		1	10	mV	
Temperature stability	ΔV_{OUT}			0.5		%	
Long Term Stability	ΔV_{OUT}	1000 hrs, $T_J=125^{\circ}C$		0.3		%	
Operating Input Voltage	V_{IN}	$I_{OUT}=100mA$			15	V	
Quiescent Current	I_Q	$V_{IN} \leq 15V$		5	10	mA	
Current Limit	I_{LIMIT}	$V_{IN}=10V, T_J=25^{\circ}C$	LD1117	800		mA	
			LD1117A	1000			
Output Noise Voltage	eN	B=10Hz to 10KHz, $T_J=25^{\circ}C$		100		μV	
Supply Voltage Rejection	SVR	$I_{OUT}=40mA, f=120Hz, T_J=25^{\circ}C,$ $V_{IN}=8V, V_{RIPPLE}=1V_{pp}$	60	75		dB	
Dropout Voltage	V_D	$I_{OUT}=100mA$ $I_{OUT}=500mA$ $I_{OUT}=800mA$ $I_{OUT}=1000mA$		1.00	1.10	V	
				1.15	1.25	V	
				1.20	1.30	V	
				1.20	1.30	V	
Thermal Regulation		$T_a=25^{\circ}C, 30ms$ Pulse		0.01	0.10	%/W	

■ ELECTRICAL CHARACTERISTICS(Cont.)

For LD1117/A-ADJUSTABLE

PARAMETER	SYMBOL	TEST CONDITIONS	MIN	TYP	MAX	UNIT
Reference Voltage	V_{REF}	$V_{IN}-V_{OUT}=2V, I_{OUT}=10mA, T_J=25^{\circ}C$	1.238	1.25	1.262	V
Reference Voltage	V_{REF}	$V_{IN}-V_{OUT}=1.4$ to 10V LD1117 : $I_{OUT}=10 \sim 800mA$ LD1117A : $I_{OUT}=10 \sim 1000mA$	1.225		1.275	V
Line Regulation	ΔV_{OUT}	$V_{IN}-V_{OUT}=1.5$ to 13.75V, $I_{OUT}=10mA$		0.035	0.200	%
Load Regulation	ΔV_{OUT}	$V_{IN}-V_{OUT}=3V$ LD1117 : $I_{OUT}=10 \sim 800mA$ LD1117A : $I_{OUT}=10 \sim 1000mA$		0.10	0.400	%
Temperature stability	ΔV_{OUT}			0.50		%
Long Term Stability	ΔV_{OUT}	1000 hrs, $T_J=125^{\circ}C$		0.3		%
Operating Input Voltage	V_{IN}				15	V
Adjustment Pin Current	I_{ADJ}	$V_{IN} \leq 15V$		60	120	μA
Adjustment Pin Current Change	ΔI_{ADJ}	$V_{IN}-V_{OUT}=1.4$ to 10V, LD1117 : $I_{OUT}=10 \sim 800mA$ LD1117A : $I_{OUT}=10 \sim 1000mA$		1	5	μA
Minimum Load Current	$I_{O(MIN)}$	$V_{IN}=15V$		2	5	mA
Current Limit	I_{LIMIT}	$V_{IN}-V_{OUT}=5V, T_J=25^{\circ}C$	LD1117	800		mA
			LD1117A	1000		
Output Noise (%Vo)	eN	B=10Hz to 10KHz, $T_J=25^{\circ}C$		0.003		%
Supply Voltage Rejection	SVR	$I_{OUT}=40mA, f=120Hz, T_J=25^{\circ}C,$ $V_{IN}-V_{OUT}=3V, V_{ripple}=1V_{pp}$	60	75		dB
Dropout Voltage	V_D		$I_{OUT}=100mA$	1.00	1.10	V
			$I_{OUT}=500mA$	1.15	1.25	V
			$I_{OUT}=800mA$	1.20	1.30	V
			$I_{OUT}=1000mA$	1.20	1.30	V
Thermal Regulation		$T_a=25^{\circ}C, 30ms$ Pulse		0.01	0.10	%/W

■ THERMAL DATA

PARAMETER	SYMBOL	RATINGS	UNIT
Thermal Resistance Junction-Case	θ_{JC}	SOT-223	15
		SOP-8	20
		TO-252	12
		TO-220	4
		TO-263	4
Thermal Resistance Junction-Ambient	θ_{JA}	SOT-223	165
		SOP-8	150
		TO-252	112
		TO-220	54
		TO-263	64

■ TYPICAL APPLICATIONS

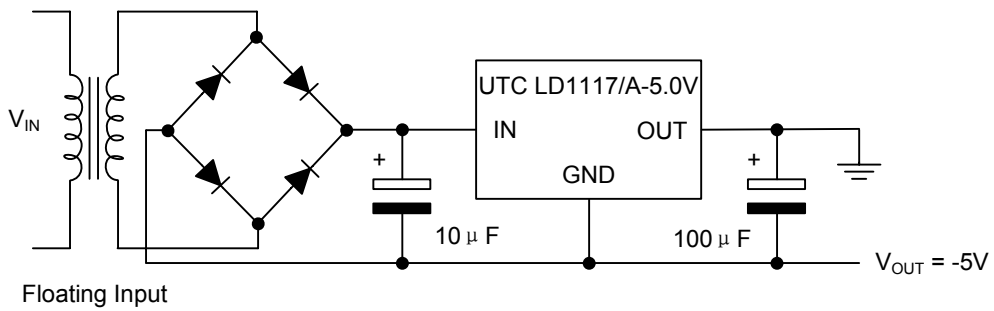

FIG.1 Negative Supply

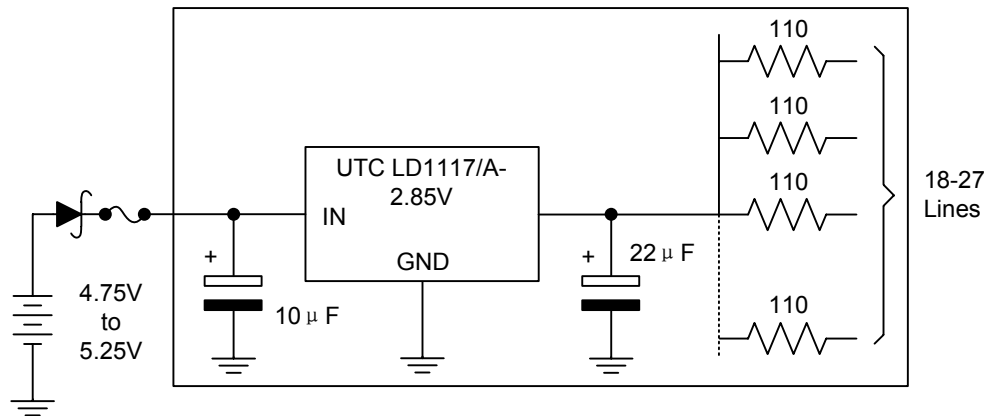

FIG.2 Active Terminator for SCSI-2 BUS

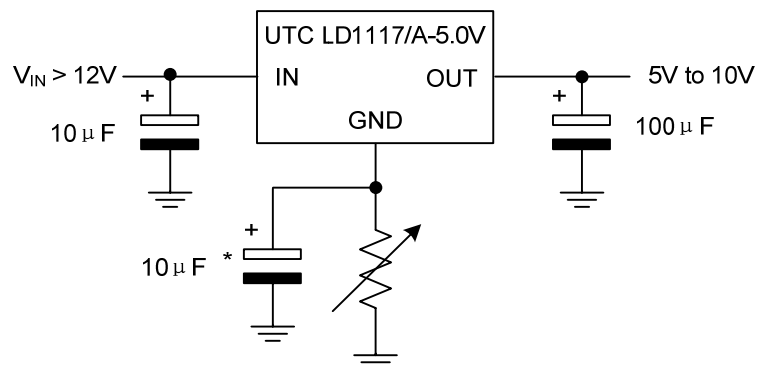

FIG.3 Circuit for Increasing Output Voltage

APPLICATION NOTE of LD1117/A ADJUSTABLE

The LD1117/A ADJUSTABLE has a reference voltage of between the OUT and ADJ pins. I_{ADJ} is 60 μ A typ. (120 μ A max.) and ΔI_{ADJ} is 1 μ A typ. (5 μ A max.).

R1 is normally fixed to 120 Ω .

From figure 4 we obtain:

$$V_{OUT} = V_{REF} + R2(I_{ADJ} + I_{R1}) = V_{REF} + R2(I_{ADJ} + V_{REF} / R1) = V_{REF}(1 + R2/R1) + R2 \times I_{ADJ}$$

Usually R2 value is in the range of few K Ω , so the $R2 \times I_{ADJ}$ product could be neglected; then the above expression becomes: $V_{OUT} = V_{REF}(1 + R2/R1)$

For better load regulation, realize a good Kelvin connection of R1 and R2 is important. Particularly R1 connection must be realized very close to OUT and ADJ pin, while R2 ground connection must be placed as near as possible to the negative Load pin. Ripple rejection can be improved by introducing a 10 μ F electrolytic capacitor placed in parallel to the R2 resistor (See Fig. 5)

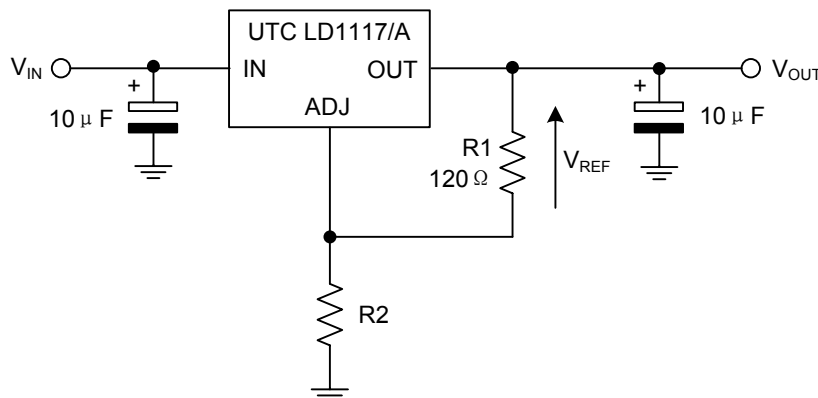

FIG.4 Adjustable Output Voltage Application Circuit

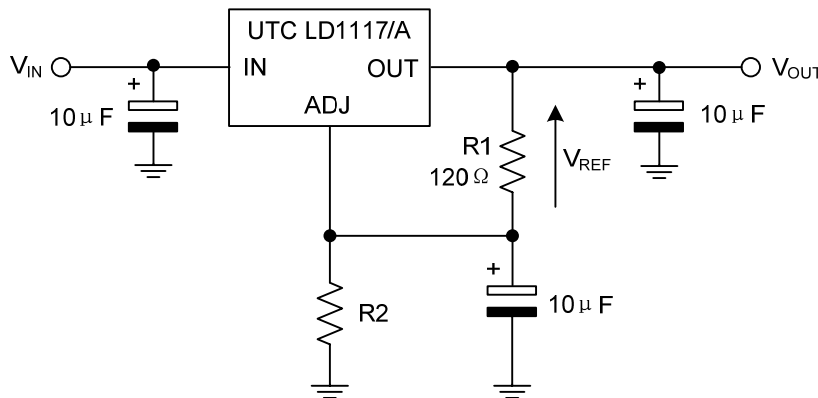
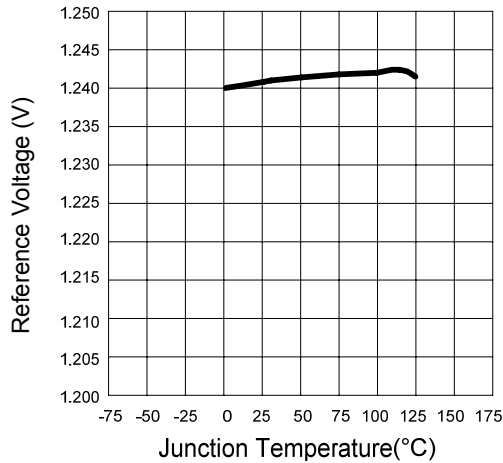

FIG.5 Adjustable Output Voltage Application with improved Ripple Rejection.

■ TYPICAL PERFORMANCE CHARACTERISTICS

Reference Voltage vs. Temperature



Output Voltage vs. Temperature

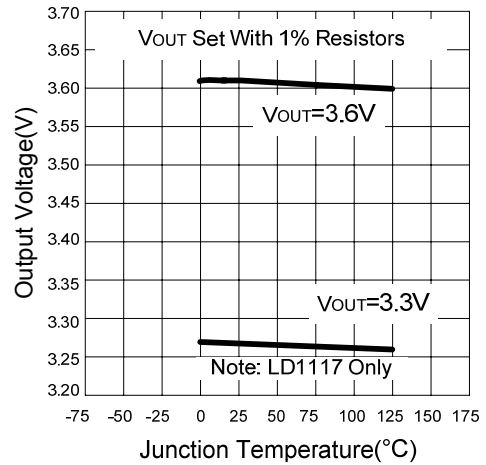

Maximum Power Dissipation

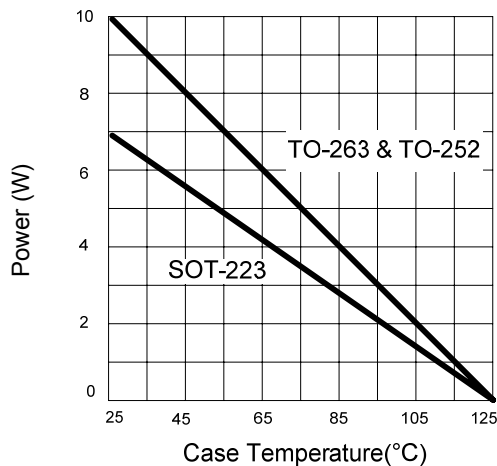

UTC assumes no responsibility for equipment failures that result from using products at values that exceed, even momentarily, rated values (such as maximum ratings, operating condition ranges, or other parameters) listed in products specifications of any and all UTC products described or contained herein. UTC products are not designed for use in life support appliances, devices or systems where malfunction of these products can be reasonably expected to result in personal injury. Reproduction in whole or in part is prohibited without the prior written consent of the copyright owner. The information presented in this document does not form part of any quotation or contract, is believed to be accurate and reliable and may be changed without notice.